













































































































































# DOUBLE HUNG

<b>MO (mm)</b>	1' - 6" (457)	2' - 0" (610)	2' - 6" (762)	2' - 8" (813)	3' - 0" (914)	3' - 6" (1067)	4' - 0" (1219)
<b>RO (mm)</b>	1' - 6" (457)	2' - 0" (610)	2' - 6" (762)	2' - 8" (813)	3' - 0" (914)	3' - 6" (1067)	4' - 0" (1219)
<b>FS (mm)</b>	1' - 5 1/2" (445)	1' - 11 1/2" (597)	2' - 5 1/2" (749)	2' - 7 1/2" (800)	2' - 11 1/2" (902)	3' - 5 1/2" (1054)	3' - 11 1/2" (1207)
<b>DLO (mm)</b>	12 9/16" (319)	18 9/16" (471)	24 9/16" (624)	26 9/16" (675)	30 9/16" (776)	36 9/16" (929)	42 9/16" (1081)

1' - 11 3/4" (603) 1' - 11 3/4" (603) 2' - 0" (610) 2' - 0" (610)							
2' - 5 3/4" (756) 2' - 5 3/4" (756) 2' - 6" (762) 2' - 6" (762)							
2' - 11 3/4" (908) 3' - 0" (914) 2' - 11 1/2" (902) 2' - 11 1/2" (902)							
3' - 5 3/4" (1060) 3' - 5 3/4" (1060) 3' - 6" (1067) 3' - 5 1/2" (1054)							
3' - 11 3/4" (1213) 4' - 0" (1219) 3' - 11 1/2" (1207) 20 5/16" (516)							
4' - 5 3/4" (1365) 4' - 5 3/4" (1365) 4' - 6" (1372) 4' - 5 1/2" (1359)							
4' - 11 3/4" (1518) 5' - 0" (1524) 4' - 11 1/2" (1511) 26 5/16" (668)							
5' - 5 3/4" (1670) 5' - 5 3/4" (1670) 5' - 6" (1676) 5' - 5 1/2" (1664)							
5' - 11 3/4" (1822) 6' - 0" (1828) 5' - 11 1/2" (1816) 32 5/16" (821)							
6' - 5 3/4" (1975) 6' - 6" (1981) 6' - 5 1/2" (1969) 35 5/16" (897)							



















































# DOUBLE HUNG

2 Wide

MO (mm)	3' - 0" (914)	4' - 0" (1219)	5' - 0" (1524)	5' - 4" (1626)	6' - 0" (1829)	7' - 0" (2134)	8' - 0" (2438)
RO (mm)	3' - 0" (914)	4' - 0" (1219)	5' - 0" (1524)	5' - 4" (1626)	6' - 0" (1829)	7' - 0" (2134)	8' - 0" (2438)
FS (mm)	2' - 11 1/2" (902)	3' - 11 1/2" (1207)	4' - 11 1/2" (1511)	5' - 3 1/2" (1600)	5' - 11 1/2" (1816)	6' - 11 1/2" (2121)	7' - 11 1/2" (2426)
1' - 11" 3/4" (603) 2' - 0" (610) 1' - 11 1/2" (697)	 ESDH1620	 ESDH2020	 ESDH2620	 ESDH2820	 ESDH3020	 ESDH3620	 ESDH4020
2' - 5 3/4" (756) 2' - 6" (762) 2' - 5 1/2" (749)	 ESDH1626	 ESDH2026	 ESDH2626	 ESDH2826	 ESDH3026	 ESDH3626	 ESDH4026
2' - 11 3/4" (908) 3' - 0" (914) 2' - 11 1/2" (902)	 ESDH1630	 ESDH2030	 ESDH2630	 ESDH2830	 ESDH3030	 ESDH3630	 ESDH4030
3' - 5 3/4" (1060) 3' - 6" (1067) 3' - 5 1/2" (1054)	 ESDH1636	 ESDH2036	 ESDH2636	 ESDH2836	 ESDH3036	 ESDH3636	 ESDH4036
3' - 11 3/4" (1213) 4' - 0" (1219) 3' - 11 1/2" (1207)	 ESDH1640	 ESDH2040	 ESDH2640	 ESDH2840	 ESDH3040	 ESDH3640	 ESDH4040
4' - 5 3/4" (1365) 4' - 6" (1372) 4' - 5 1/2" (1359)	 ESDH1646	 ESDH2046	 ESDH2646	 ESDH2846	 ESDH3046	 ESDH3646	 ESDH4046
4' - 11 3/4" (1518) 5' - 0" (1524) 4' - 11 1/2" (1511)	 ESDH1650	 ESDH2050	 ESDH2650	 ESDH2850	 ESDH3050 E	 ESDH3650 E	 ESDH4050 E
5' - 5 3/4" (1670) 5' - 6" (1676) 5' - 5 1/2" (1664)	 ESDH1656	 ESDH2056	 ESDH2656	 ESDH2856	 ESDH3056 E	 ESDH3656 E	 ESDH4056 E
5' - 11 3/4" (1822) 6' - 0" (1829) 5' - 11 1/2" (1816)	 ESDH1660	 ESDH2060	 ESDH2660 E	 ESDH2860 E	 ESDH3060 E	 ESDH3660 E	 ESDH4060 E
6' - 5 3/4" (1975) 6' - 6" (1981) 6' - 5 1/2" (1969)	 ESDH1666	 ESDH2066	 ESDH2666 E	 ESDH2866 E	 ESDH3066 E	 ESDH3660 E	 ESDH4066 E





















# DOUBLE HUNG

## 3 Wide

MO (mm)	4' - 6" (1372)	6' - 0" (1829)	7' - 6" (2286)	8' - 0" (2438)	9' - 0" (2743)
RO (mm)	4' - 6" (1372)	6' - 0" (1829)	7' - 6" (2286)	8' - 0" (2438)	9' - 0" (2743)
FS (mm)	4' - 5 1/2" (1359)	5' - 11 1/2" (1816)	7' - 5 1/2" (2273)	7' 11 1/2" (2413)	8' - 11 1/2" (2731)
1' - 11 3/4" (603) 2' - 0" (610) 1' - 11 1/2" (597)	 ESDH1620	 ESDH2020	 ESDH2620	 ESDH2820	 ESDH3026
2' - 5 3/4" (756) 2' - 6" (762) 2' - 5 1/2" (749)	 ESDH1626	 ESDH2026	 ESDH2626	 ESDH2826	 ESDH3026
2' - 11 3/4" (908) 3' - 0" (914) 2' - 11 1/2" (902)	 ESDH1630	 ESDH2030	 ESDH2630	 ESDH2830	 ESDH3030
3' - 5 3/4" (1060) 3' - 6" (1067) 3' - 5 1/2" (1054)	 ESDH1636	 ESDH2036	 ESDH2636	 ESDH2836	 ESDH3036
3' - 11 3/4" (1213) 4' - 0" (1219) 3' - 11 1/2" (1207)	 ESDH1640	 ESDH2040	 ESDH2640	 ESDH2840	 ESDH3040
4' - 5 3/4" (1365) 4' - 6" (1372) 4' - 5 1/2" (1359)	 ESDH1646	 ESDH2046	 ESDH2646	 ESDH2846	 ESDH3046
4' - 11 3/4" (1518) 5' - 0" (1524) 4' - 11 1/2" (1511)	 ESDH1650	 ESDH2050	 ESDH2650	 ESDH2850	 ESDH3050 E
5' - 5 3/4" (1670) 5' - 6" (1676) 5' - 5 1/2" (1664)	 ESDH1656	 ESDH2056	 ESDH2656	 ESDH2856	 ESDH3056 E
5' - 11 3/4" (1822) 6' - 0" (1829) 5' - 11 1/2" (1816)	 ESDH1660	 ESDH2060	 ESDH2660 E	 ESDH2860 E	 ESDH3060 E
6' - 5 3/4" (1975) 6' - 6" (1981) 6' - 5 1/2" (1969)	 ESDH1666	 ESDH2066	 ESDH2666 E	 ESDH2866 E	 ESDH3066 E

# DOUBLE HUNG

## 4 Wide

MO (mm)	6' - 0" (1829)	8' - 0" (2438)
RO (mm)	6' - 0" (1829)	8' - 0" (2438)
FS (mm)	5' - 11 1/2" (1816)	7' - 11 1/2" (2426)
1' - 11" 3/4" (603) 2' - 0" (610) 1' - 11 1/2" (597)	 ESDH1620	 ESDH2020
2' - 5 3/4" (756) 2' - 6" (762) 2' - 5 1/2" (749)	 ESDH1626	 ESDH2026
2' - 11 3/4" (908) 3' - 0" (914) 2' - 11 1/2" (902)	 ESDH1630	 ESDH2030
3' - 5 3/4" (1060) 3' - 6" (1067) 3' - 5 1/2" (1054)	 ESDH1636	 ESDH2036
3' - 11 3/4" (1213) 4' - 0" (1219) 3' - 11 1/2" (1207)	 ESDH1640	 ESDH2040
4' - 5 3/4" (1365) 4' - 6" (1372) 4' - 5 1/2" (1359)	 ESDH1646	 ESDH2046
4' - 11 3/4" (1518) 5' - 0" (1524) 4' - 11 1/2" (1511)	 ESDH1650	 ESDH2050
5' - 5 3/4" (1670) 5' - 6" (1676) 5' - 5 1/2" (1664)	 ESDH1656	 ESDH2056
5' - 11 3/4" (1822) 6' - 0" (1829) 5' - 11 1/2" (1816)	 ESDH1660	 ESDH2060
6' - 5 3/4" (1975) 6' - 6" (1981) 6' - 5 1/2" (1969)	 ESDH1666	 ESDH2066

GBG available in standard Rectangular lite cut, shown. Other GBG lite cuts shown on page 3.

E = These windows (in equal sash) meet National Egress Codes for fire evacuation. Local codes may differ.

Details and Elevations not to scale.

Available in equal, cottage, and reverse cottage sash configurations. Cottage and reverse cottage sash configurations are not available on 20, 60, and 66 call number heights.

Obscure Glass option available on all units.

Units may optionally include a window opening control device tested to ASTM F2090-10, which can be released from the inside without the use of a key, tool, special knowledge, or force greater than that required for normal unit operation.

Special sized units available within product size matrix. See your Marvin retailer.

See page 52 for specific PG Ratings.

For further details and drawings visit the 'Tools and Documents' section at Marvin.com.

### MULTIPLE ASSEMBLIES

Multiple assemblies can be factory mullied.

MAXIMUM ROUGH OPENING not to exceed 114" x 78".

Maximum up to 6 units wide by 1 unit high.

MAXIMUM ROUGH OPENING not to exceed 96" x 96".

Maximum up to 5 units wide by 5 units high.

Field mull kits are available. Structural mullion reinforcement is required for some assemblies.

Please consult your local Marvin representative for more information.

# DOUBLE HUNG - Transoms and Multiple Assemblies

## Transom Muller Over Double Hung

MO (mm)	2' - 6" (762)
RO (mm)	2' - 6" (762)
FS (mm)	2' - 5 1/2" (749)

5' - 11 3/4" (1822)
6' - 0" (1829)
5' - 11 1/2" (1816)

ESDHTR2616

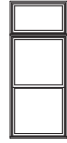

ESDH2646

## Transom Muller Over Double Hung 2 Wide

MO (mm)	5' - 0" (1524)
RO (mm)	5' - 0" (1524)
FS (mm)	4' - 11 1/2" (1511)

5' - 11 3/4" (1822)
6' - 0" (1829)
5' - 11 1/2" (1816)

ESDHTR5016

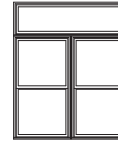

ESDH2646 / ESDH2646

## Double Hung Flankers with Center Picture\*

MO (mm)	10' - 0" (3048)
RO (mm)	10' - 0" (3048)
FS (mm)	9' - 11 1/2" (3035)

4' - 5 3/4" (1365)
4' - 6" (1372)
4' - 5 1/2" (1359)

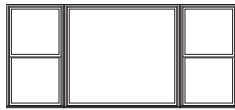

ESDH2646 / ESDHP5046 / ESDH2646

## Double Hung Flankers with Center Operator

MO (mm)	7' - 6" (2286)
RO (mm)	7' - 6" (2286)
FS (mm)	7' - 5 1/2" (2273)

4' - 5 3/4" (1365)
4' - 6" (1372)
4' - 5 1/2" (1359)



ESDH2646 / ESDH2646 / ESDH2646

## Construction Details

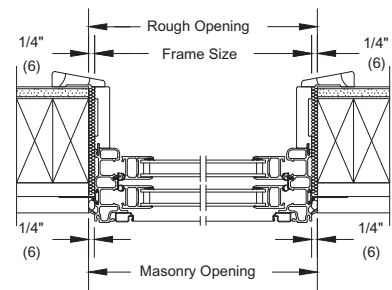

Jamb

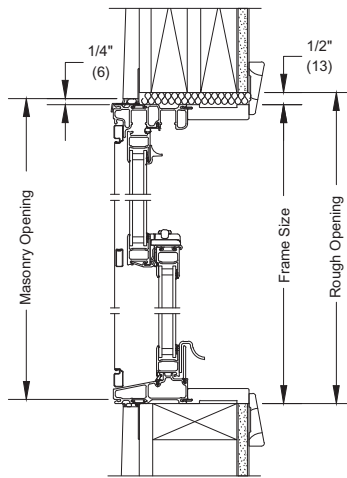

Head Jamb & Sill

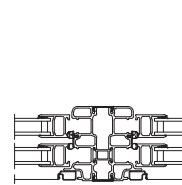

Vertical Mullion



Horizontal Mullion Transom/Operator

\* This product is only available field muller.

Details and Elevations not to scale.

Available in equal, cottage, and reverse cottage sash configurations. Cottage and reverse cottage sash configurations are not available on 20, 60, and 66 call number heights.

Obscure Glass option available on all units.

Special sized units available within product size matrix. See your Marvin retailer.

Units may optionally include a window opening control device tested to ASTM F2090-10, which can be released from the inside without the use of a key, tool, special knowledge, or force greater than that required for normal unit operation.

See page 52 for specific PG Ratings.

For further details and drawings visit the 'Tools and Documents' section at Marvin.com.

### MULTIPLE ASSEMBLIES

Multiple assemblies can be factory muller.

MAXIMUM ROUGH OPENING not to exceed 114" x 78". Maximum up to 6 units wide by 1 unit high.

MAXIMUM ROUGH OPENING not to exceed 96" x 96". Maximum up to 5 units wide by 5 units high.

Field mull kits are available. Structural mullion reinforcement is required for some assemblies.

Please consult your local Marvin representative for more information.